

BENDIX VALVES

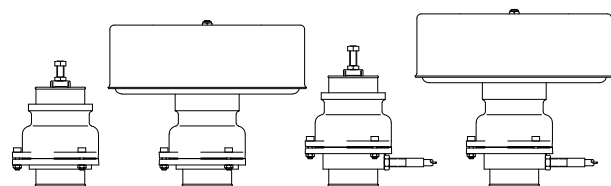

- D45 40-70
- D45F 40-70
- D45-AM 40-70
- D45F-AM 40-70
- D51 51-80
- D51F 51-80
- D51-AM 51-80
- D51F-AM 51-80
- D57 57-83
- D57F 57-83
- D57-AM 57-83
- D57F-AM 57-83
- D64 63-96
- D64F 63-96
- D64-AM 63-96
- D64F-AM 63-96
- D70 70-102
- D70-AM 70-102
- D80 70-108
- D80-AM 70-108

(ALL VERSIONS AVAILABLE WITH Y OPTION)
(AM VERSIONS COME WITH RTD-100 HANDLE & CLD-XXX CABLE)

AIR PRESSURE TO STOP

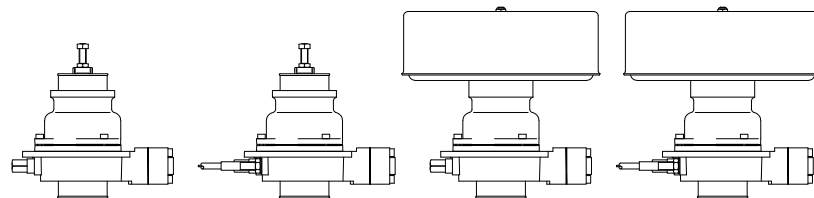

- TPZ-103 51-70
- TPZ-104 51-70
- TPZ-203 51-70
- TPZ-204 51-70
- TPZ-105 51-80
- TPZ-106 51-80
- TPZ-205 51-80
- TPZ-206 51-80
- TPZ-107 57-83
- TPZ-108 57-83
- TPZ-207 57-83
- TPZ-208 57-83
- TPZ-109 63-96
- TPZ-110 63-96
- TPZ-209 63-96
- TPZ-210 63-96
- TPZ-301 70-102
- TPZ-311 70-102
- TPZ-302 70-108
- TPZ-312 70-108

(TPZ-3XX VERSIONS AVAILABLE WITH Y OPTION)
(WHERE APPLICABLE TPZ VALVES COME WITH RTD-100 HANDLE & CLD-XXX CABLE)

OIL PRESSURE TO RUN

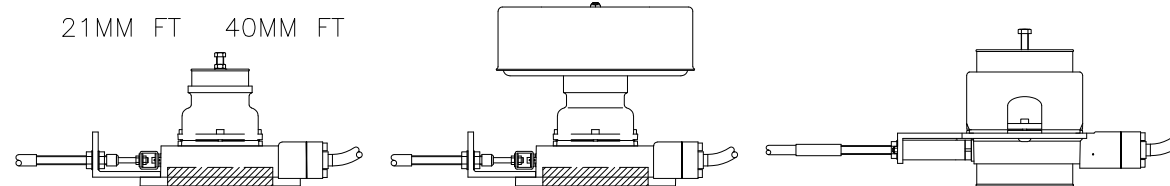

- | | | | | |
|---------------|---------------|-------------|-------------|-----------------------|
| 21MM FT | 40MM FT | | | |
| TMZ-121 40-70 | TMZ-125 40-70 | TMZ-221 N/A | TMZ-225 N/A | TMZ-131 51-70 |
| TMZ-122 51-80 | TMZ-126 51-80 | TMZ-222 N/A | TMZ-226 N/A | TMZ-132 51-80 |
| TMZ-123 57-83 | TMZ-127 57-83 | TMZ-223 N/A | TMZ-227 N/A | TMZ-133 57-83 |
| TMZ-124 63-96 | TMZ-128 63-96 | TMZ-224 N/A | TMZ-228 N/A | TMZ-134 63-96 |
| | | 21MM | 40MM | TMZ-301 70-102 |
| | | FLAMETRAP | SIZE | TMZ-302 70-108 |
| | | | | ZMZ-303 70-108 / M110 |

(ALL TMZ VERSIONS COME WITH THE RLZ-100 HANDLE & CHW-XXX CABLE)

(TMZ-3XX VERSIONS AVAILABLE WITH Y OPTION)

SPINDLE VALVES

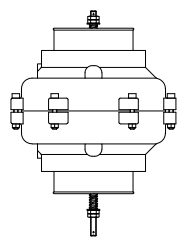

- D92 76-115
- D92S 76-115
- D102 89-115
- D102S 89-115
- D121 101-140
- D121S 101-140
- D136 126-154
- D136S 126-154
- D200 152-229
- D200S 152-229
- D200SX 152-229

CABLE TO STOP

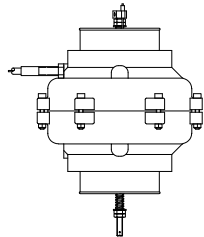

- D92-AM 76-115
- D92S-AM 76-115
- D102-AM 89-115
- D102S-AM 89-115
- D121-AM 101-140
- D121S-AM 101-140
- D136-AM 126-154
- D136S-AM 126-154
- D200-AM 152-229
- D200S-AM 152-229
- D200SX-AM 152-229

AIR PRESSURE TO STOP

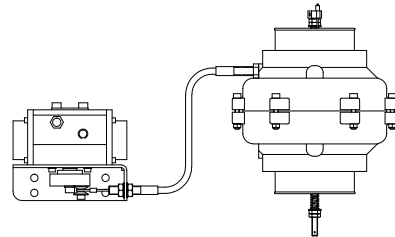

- D92-AP 76-115
- D92S-AP 76-115
- D102-AP 89-115
- D102S-AP 89-115
- D121-AP 101-140
- D121S-AP 101-140
- D136-AP 126-154
- D136S-AP 126-154
- D200-AP 152-229
- D200S-AP 152-229
- D200SX-AP 152-229

AIR PRESSURE OR CABLE TO STOP

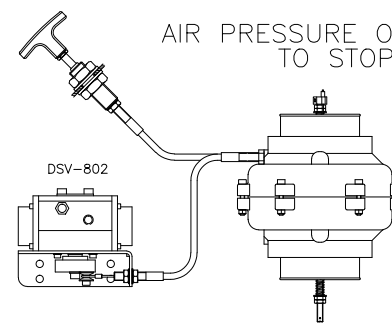

- D92-AMP 76-115
- D92S-AMP 76-115
- D102-AMP 89-115
- D102S-AMP 89-115
- D121-AMP 101-140
- D121S-AMP 101-140
- D136-AMP 126-154
- D136S-AMP 126-154
- D200-AMP 152-229
- D200S-AMP 152-229
- D200SX-AMP 152-229

OIL PRESSURE TO RUN

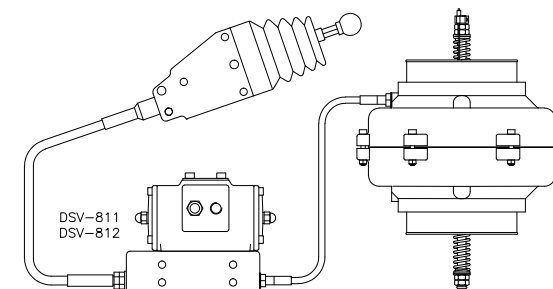

- D92-AMZ 76-115
- D92S-AMZ 76-115
- D102-AMZ 89-115
- D102S-AMZ 89-115
- D121-AMZ 101-140
- D121S-AMZ 101-140
- D136-AMZ 126-154
- D136S-AMZ 126-154
- D200-AMZ 152-229
- D200S-AMZ 152-229
- D200SX-AMZ 152-229

(D92/D92S/D102/D102S/D121 AM/AP/AMP VERSIONS COME WITH RTD-100 HANDLE & CLD-XXX CABLE, D121S/D136/D136S AM/AP/AMP VERSIONS COME WITH RLD-100 HANDLE & CLD-XXX CABLE, D200/D200S AM/AP/AMP VERSIONS COME WITH RTD-100 HANDLE & CLE-XXX CABLE.)

(AMZ VERSIONS COME WITH RLZ-100 HANDLE & CHW-XXX CABLE.)

MINI BENDIX VALVES

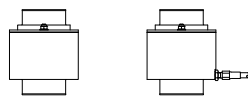

- D29 25-34
- D29-AM 25-34
- D30 35-45
- D30-AM 35-45
- D41 38-58
- D41-AM 38-58

(AM VERSIONS COME WITH RTD-200 HANDLE & CSD-XXX CABLE)

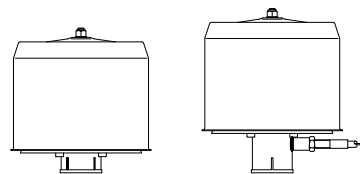

- D34BF 35/38
- D34BF-AM 35/38
- D35BF 35/38
- D35BF-AM 35/38
- D39BF 40/42/44
- D39BF-AM 40/42/44

(AM VERSIONS COME WITH RTD-100 HANDLE & CLD-XXX CABLE)

**TITLE: PRODUCT RANGE SHEETS
- D, TPZ & TMZ VALVES**

This drawing is the property of CHALWYN LTD. No part of this drawing may be divulged or used without our express permission. © CHALWYN LTD 2007

Issue:	2	3			SCALE:
Date:	01/06/2007	10/04/2008			DIMENSIONS:
Drawn	A.C.T.	CHALWYN LTD			TOLERANCES:
Date	01/06/2007	Chalwyn Industrial Estate, Parkstone, Poole, Dorset. BH12 4PF. Tel: 01202 715200 Fax: 01202 715600			DRAWING No. INF-001
					Sheet 1 of 3