

Instructions for Installation and Maintenance

For all 2 in. (51 mm) and 2-1/2 in. (64 mm) Dial Temperature MURPHYGAGE® and SWICHGAGE®

T-8446N
Revised 09-02
Section 10
(00-02-0168)



Please read the following information before installing. A visual inspection of this product for damage during shipping is recommended before mounting. General information and these installation instructions are intended for all 20T, 25T, A20T, and A25T series models.

GENERAL INFORMATION

WARNING

BEFORE BEGINNING INSTALLATION OF THIS MURPHY PRODUCT

- ✓ Disconnect all electrical power to the machine.
- ✓ Make sure the machine cannot operate during installation.
- ✓ Follow all safety warnings of the machine manufacturer.
- ✓ Read and follow all installation instructions.



Description

Murphy 2 in. (51 mm) and 2-1/2 in. (64 mm) MURPHYGAGE® and SWICHGAGE® instruments have a remote sensing bulb connected to the gauge head by a sealed capillary system. **DO NOT CUT THIS CAPILLARY OR BEND AT A SHARP ANGLE.** The sensing bulb and capillary are filled with a liquid.

When heat is applied to the sensing bulb the liquid turns to vapor which exerts pressure against the diaphragm movement of the gauge. This movement is read on the dial face as temperature.

Models having face adjustable contact(s) are rated for 2 A @ 30 V (pilot duty). If the case is steel (models 20T, 20SD, 25T, etc.), the ground path for the contact circuit is through the case. Therefore, the case must be installed in the ground plane of the electrical power supply.

If the case is polycarbonate (models A20T, A25T), the ground path is isolated and is made through the "C" or "P" terminal on the back of the case.

Models 20TE, A20TE, 25TE and A25TE have a snap-acting switch instead of the face adjusted pointer type contact. Electrical rating is 3 A @ 30 VDC, 4 A @ 125 VAC. Reset differential for the switch is approximately 10% of the scale below the trip point. Trip point is factory set and must be special ordered for field adjustable.

SWICHGAGE® models with Alarm Before Shut-down

The 20TABS, A20TABS, 25TABS and A25TABS feature a front limit contact for high temperature equipment shut-down and an internal SPDT snap switch for Alarm Before Shut-Down (see Wiring Diagram, page 3). When the high side (preset high temperature point) of the snap switch trips, the N.O. terminal completes a circuit to activate an alarm. A continued increase in temperature will complete the shutdown circuit. A decrease in temperature of approximately 10% of scale is necessary before the snap-switch (alarm) will RESET and open the circuit.

NOTE: The front contact shut-down limit setting (adjustable) and snap switch high point are preset at the factory; if settings other than standard are necessary, then specify when ordering.

Typical TATTLETALE® Magnetic Switch

Murphy manufactures several, patented Magnetic Switches for protection of the light duty SWICHGAGE® contacts and to ensure positive shut-down of equipment. There are Magnetic Switches for Capacitor Discharge ignition, Magneto, or Battery systems, and models for electric motor

driven equipment. TATTLETALE® annunciators are indicators that show the cause of shut-down. TATTLETALE® annunciators are used in conjunction with several different SWICHGAGE® instruments. Selected TATTLETALE® models can be wired so that the first one to trip will lockout all other TATTLETALE®s. Be sure the type of Magnetic Switch matches the power source used to trip it.

NOTE: At equipment start-up, the Magnetic Switch reset button must be held in until normal operation occurs, or an external time delay may be used. See examples of typical wiring and instructions packed with each Magnetic Switch.



CAUTION: Certain dangers to human safety and to equipment may occur if some equipment is stopped without pre-warning. It is recommended that monitored functions be limited to alarm-only or to alarm before shutdown.

IMPORTANT: SWICHGAGE® instruments, Magnetic Switches and shut-down or alarm devices, properly used, are effective tools in any preventive maintenance program. For optimum performance, check these tools periodically: look for frozen pointers, kinked/worn tubing, broken wiring or loose connections; operate the contacts and watch for expected results. Replace damaged/worn parts; clean/repair as necessary. Check for correct/complete wiring, unbroken insulation and no accidental grounds. **DO NOT run shut-down wires with ignition wiring.** Check all tubing and connections for leaks. Mount Magnetic Switches and valves upright, to prevent moisture collection.

MOUNTING DIMENSIONS

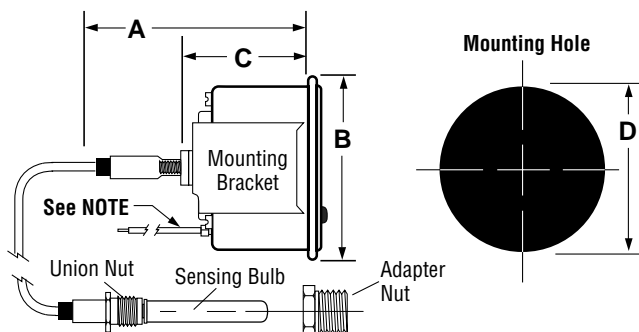

For All 20, 25, A20, and A25 Series Temperature MURPHYGAGE® and SWICHGAGE® instruments

	20 Series	A20 Series	25 Series	A25 Series
A	2-7/32 (56)	2-9/64 (54)	2-1/8 (54)	1-51/64 (46)
B	2-15/64 (57)	2-1/4 (57)	3-1/8 (79)	2-29/32 (74)
C	1-5/16 (33)	1-27/64 (36)	1-3/8 (35)	1-27/64 (36)
D	2-1/16 (53)	2-1/16 (53)	2-11/16 (68)	2-11/16 (68)

NOTE: The dimensions above are in inches and (millimeters).

* Products covered by this literature comply with EMC Council directive 89/336/EEC regarding electromagnetic compatibility except as noted.

NOTE: 20 and 25 Series have 18 AWG pigtailed. A20 series has #4 screws. A25 series has #6 screws.

INSTALLATION



WARNING: DISCONNECT THE BATTERY OR POWER SOURCE BEFORE BEGINNING THE INSTALLATION. DO NOT OPEN RADIATOR CAP OR FITTINGS ON A HOT ENGINE. DANGEROUS BURNS CAN OCCUR.

Panel Mounting

The 20, 25, A20 and A25 series models can be installed in a panel from 0.032 in. (1 mm) to 0.250 in. (6 mm) thick. See Mounting Dimensions, page 1. Remove the mounting bracket completely and insert the MURPHY-GAGE®/SWICHGAGE® from the front side of the panel. Replace the bracket and secure it in place. **IMPORTANT: Do NOT overtighten the mounting bracket. Shockmount the panel as necessary.**

LIQUID COOLED ENGINES:

1. Drain engine coolant to a level below the temperature sensing connection/plug. This connection is on the engine side of the thermostat generally near thermostat housing. *Consult your engine manual.*
2. Remove adapter nut from temperature sensing bulb and union nut.
3. Apply a non-hardening thread sealant to the adapter nut and screw securely into the water jacket opening in the engine.
4. Route the temperature capillary **AWAY** from hot surfaces such as exhaust manifolds.
5. Place the sensing bulb into the adapter nut and observe that the sensing bulb does not "bottom" in the water jacket nor are there other obstructions in the water jacket opening. Secure sensing bulb into the adapter nut with the 5/8-18 union nut. See Figure 2.

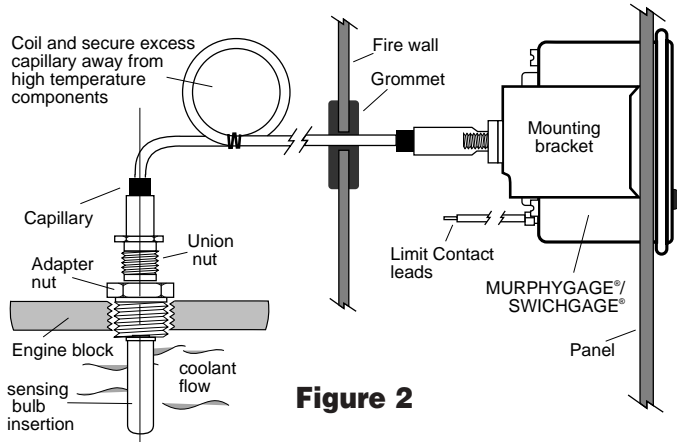

Figure 2

Connecting the TATTLETALE®/Magnetic Switch

1. Mount with electrical lugs down. If necessary, drill the case and pilot-stud holes (template provided).
2. Clean away burrs and filings. Position the Magnetic Switch in the panel, making sure the pilot stud is in place.
3. Add decal, then washer, then nut and tighten.

NOTE: Murphy components are easily wired and maintained. Use good quality wire and terminals. The type of Magnetic Switch differs for various applications. See examples of typical wiring (below). Wiring and instructions are packed with each Magnetic Switch.

Typical N.O. SWICHGAGE® Instruments Wiring

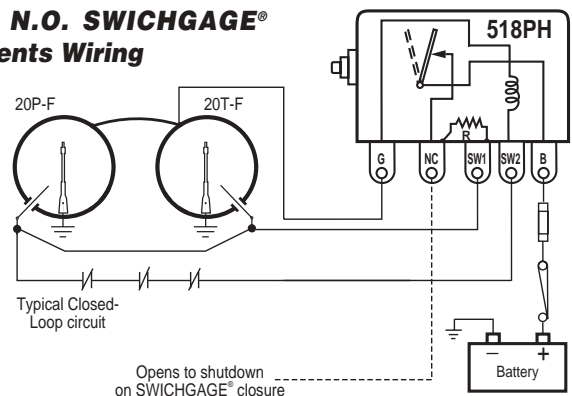

Typical Alarm Before Shutdown Wiring

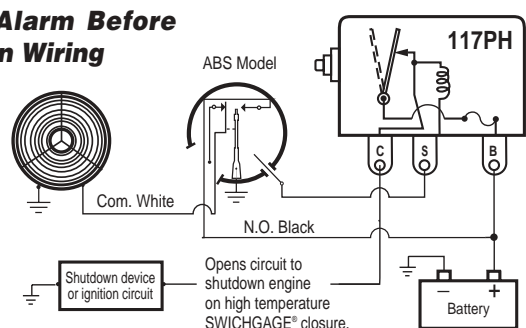

IMPORTANT INFORMATION: Do NOT clean MURPHY-GAGE®, SWICHGAGE® and Magnetic Switch with steam or high pressure washes. Many solvents and cleaners can haze and permanently damage the clear, polycarbonate. Clean your devices with: mild soap and water, mineral spirits, methyl/isopropyl/isobutyl alcohols, or 1 & 3 denatured alcohols. **WARNING:** Do not clean the MURPHY-GAGE®/SWICHGAGE® - Magnetic Switch when equipment is running or very hot.



CAUTION: Do NOT cut or bend the temperature capillary at a sharp angle. Excess capillary must be carefully coiled and secured. The temperature sensing bulb must be immersed directly into the water jacket flow to sense coolant temperature. Do NOT install into a tee or other fitting. Use only Murphy adapter nuts.

6. Coil excess temperature capillary into a 2 in. (51 mm) diameter minimum coil. Tie the coil to prevent excessive movement.
7. Allow the engine to warm up and the thermostat to open. Slightly loosen the 5/8-18 union nut on the temperature sensing bulb to allow trapped air to escape from the cooling system. Retighten the nut.



WARNING: Perform this operation using appropriate protection. Trapped air and coolant may cause burns.

AIR COOLED ENGINES:

Temperature for air cooled engine can be measured in the cylinder head or in the lubricating oil. Oil temperature will give a more uniform reading than cylinder head since the oil circulates throughout the engine. Refer to specific instructions supplied, if any, for your specific application.

1. *Oil Temperature*
 - a. The SWICHGAGE® sensing probe must be fully immersed in the oil pan, oil filter housing, oil cooler, etc. depending on engine model and configuration.
 - b. Observe all precautions for liquid cooled engines.
2. *Cylinder Head Temperature*
 - a. Generally the cylinder head must already have a hole drilled and tapped for insertion of the temperature sensing probe.
 - b. If a hole is not provided in the cylinder head and no provision is made to drill and tap one, it may be possible to install an external bolt on heat sink such as the Murphy HS7.
 - c. Coat the temperature sensing probe with a high temperature grease. A mixture of silicone and graphite flakes is recommended although grease alone can be used.



CAUTION: Do NOT apply too much grease. If grease is pushed out of the hole when temperature probe is inserted, remove some grease.

- d. Observe all precautions for liquid cooled engines.

INSTALLATION Continued

Setting the SWICHGAGE® contacts



IMPORTANT: For 20TE, 25TE, A20TE and A25TE models the switch trip point **CANNOT** be set at either the lowest or the highest extremes of the scale. Trip point **MUST** allow for the switch reset differential. For adjustable switch versions, the switch point is adjustable **ONLY** over the upper half of the scale.

1. All contacts are set using a 1/16 in. hex wrench (Figure 3).
2. Some models such as A20TE, A25TE, etc. may not have field adjustment. Consult the factory if in doubt.
3. Observe the “normal operating” temperature readings. Set the contact slightly **above** maximum reading observed or slightly **below** maximum temperature recommended by equipment manufacturer.

Testing the Contacts

1. With equipment running; use a 1/16 in. hex wrench to rotate contact until it touches the pointer. **Do NOT force contact against the gage pointer.** Equipment should shut down and/or alarm should operate. Reset the contact (Figure 3).
2. **VERY IMPORTANT** Each time you start the machine, observe that the SWICHGAGE® is indicating temperature. Visual inspection and regular testing should be normal procedure to ensure proper operation and to achieve maximum results from your SWICHGAGE®.

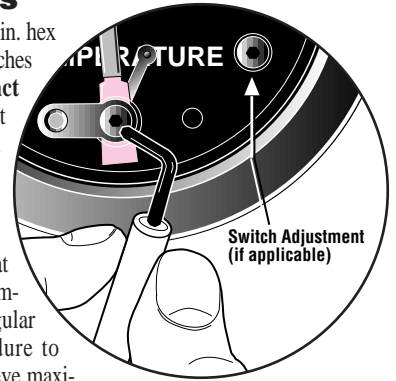

Figure 3

TYPICAL WIRING DIAGRAMS



WARNING: DISCONNECT ALL ELECTRICAL POWER BEFORE BEGINNING THE WIRING INSTALLATION

20 and 25 Series models

These diagrams are shown with the pointer in the at rest (shelf) position.

Pointer contact rating: pilot duty 2 A @ 30 VAC/DC.

Snap-switch rating: 3 A @ 30 VDC, 4 A @ 125 VAC.

20T and 25T

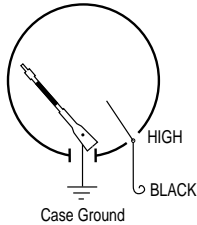

20T-HL and 25T-HL

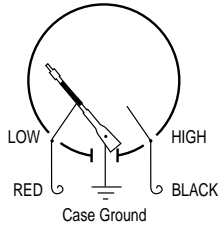

20TABS and 25TABS

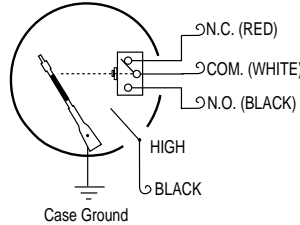

20TE and 25TE

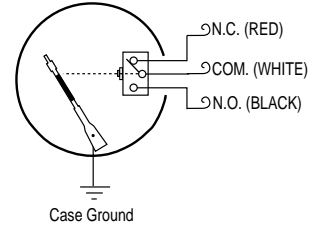

A20 Series models

These diagrams are shown with the pointer in the at rest (shelf) position.

Pointer contact rating: pilot duty 2 A @ 30 VAC/DC.

Snap-switch rating: 3 A @ 30 VDC, 4 A @ 125 VAC.

A20T

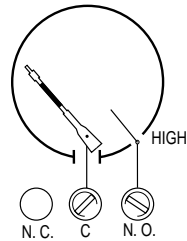

A20T-HL

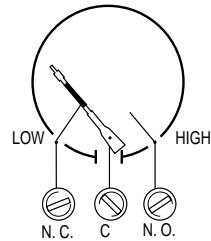

A20TABS*

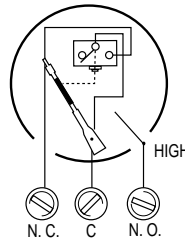

A20TE

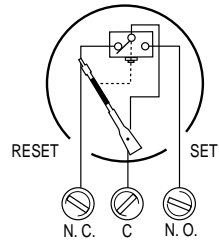

* **CAUTION** Pointer contact and ABS switch share the same “Common”. Voltage source **MUST** be the same. Maximum voltage is 30 V. Consult factory for 120 VAC applications.

A25 Series models

These diagrams are shown with the pointer in the at rest (shelf) position.

Pointer contact rating: pilot duty 2 A @ 30 VAC/DC.

Snap-switch rating: 3 A @ 30 VDC, 4 A @ 125 VAC.

A25T

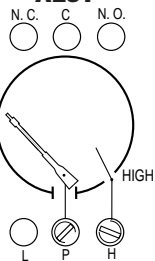

A25T-HL

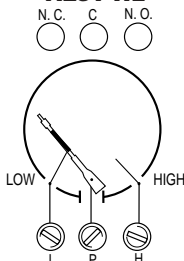

A25TABS

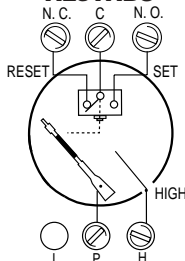

A25TABS-HL

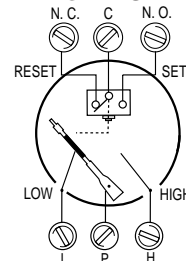

A25TE

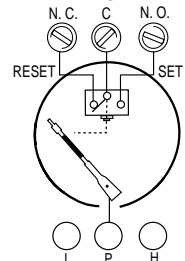

TROUBLESHOOTING TIPS

DO THIS FIRST:

Verify that the SWICHGAGE® has not been damaged (hit or dropped).
 Check for kinked or broken/worn capillary tubing.
 Verify that the sensing bulb is immersed in coolant flow.

Look for broken wiring, frozen pointer, dirty contacts (will not make).
 Verify that there is coolant or water flowing inside the engine.
 Reset Magnetic Switch and verify that it stays latched.

The following information will assist in the correction of most problems which you may encounter with the unit. If any problems persist after you have made these checks, consult your nearest Murphy facility.

SYMPTOM	CAUSE	TEST/REMEDY
Engine will not start.	<ol style="list-style-type: none"> 1. Short or Open circuit, be sure that the Magnetic Switch latches and either puts out power to run device or removes ground (magneto or CD ignition). Check for power or ground at run device. 2. Control circuit overloaded by accessories (blown fuse in Magnetic Switch). 3. False ground in control circuit. 	<ol style="list-style-type: none"> 1. Reset Magnetic Switch and make sure it stays latched. For 518PH check battery voltage and place a jumper between SW1 and SW2. If switch latches, check SWICHGAGE® wiring circuit and repair. If switch does not latch, repair or replace Magnetic Switch. 2. Find the cause of the blown fuse and replace it (use a 14 A fuse). Reroute the accessories. 3. Repair.
False shutdown.	<ol style="list-style-type: none"> 1. SWICHGAGE® circuit has intermittent open or short. 2. Vibration causes the Magnetic Switch to trip. 	<ol style="list-style-type: none"> 1. Check all wiring and replace as necessary. 2. Repair and relocate the switch as needed.
SWICHGAGE® closes but does not trip the magnetic switch or kill the engine.	<ol style="list-style-type: none"> 1. Incomplete shutdown circuit. 2. Dirty SWICHGAGE® contacts. 3. Magneto not providing power to primary terminal post. 4. SWICHGAGE® case may not be grounded. 5. Incorrect Magnetic Switch for type of power. 	<ol style="list-style-type: none"> 1. Locate open circuit and repair. 2. Clean and check that contacts make. 3. Repair magneto. 4. Ground case. 5. Replace with correct Magnetic Switch.
TATTLETALE® tripped but engine is still running (magneto or CD ignition)	<ol style="list-style-type: none"> 1. Open circuit between the TATTLETALE® and the shutdown device. 2. Lost ground to kill the engine. 	<ol style="list-style-type: none"> 1. Check wiring from TATTLETALE® to shutdown device, repair or replace. 2. Check all wiring and connections and repair.
Pointer will not operate properly. Inaccurate reading.	<ol style="list-style-type: none"> 1. Frozen pointer 2. Loose pointer spring (caused by hitting or dropping gauge). 3. Bulb not inserted to full length or low coolant level. 4. Kinked/crimped/broken capillary. 5. Height difference between gage and bulb not taken in consideration. 6. Over temperature. 	<ol style="list-style-type: none"> 1. Return for repair or replace. 2. Return for repair or replace. 3. Correct. 4. Correct. 5. Specify height difference (over 5 feet) when ordering gage. 6. Return for repair or replace.
Pointer or contact burned-in-two.	<ol style="list-style-type: none"> 1. Without exception this condition is caused by incorrect wiring or a short circuit. 	<ol style="list-style-type: none"> 1. Refer to wiring diagram and recheck wiring; replace SWICHGAGE® or return for repair. Observe voltage and current ratings.

Warranty

A two-year warranty on materials and workmanship is given with this FWMurphy product. A copy of the warranty may be viewed or printed by going to www.fwmurphy.com/warranty.asp.



Call MurCal To Place Your Order



(661) 272-4700 Fax: (661) 947-7570
 www.murcal.com email: sales@murcal.com

